



Equipment for the Foodservice Industry

value + quality + service

Work Top Freezer

FWDR2-48VC



FWDR2-48VC

Features

Features:

- Exterior & interior stainless steel construction
- Environmentally friendly R290 refrigerant
- Heavy duty Embraco compressor
- Self-closing and stay open door
- Efficient refrigeration system holds -8°F to 1°F (-22°C to -18°C)
- Recessed door handle
- Removable gasket that is easy to clean and replace
- Casters for easy movement
- Pre-installed shelves

Warranty:

- Two year parts and labour; Five years on compressor. *For full warranty details visit <https://www.efifoodequip.com/warranty-info.php>*



FWDR2-48VC Specifications

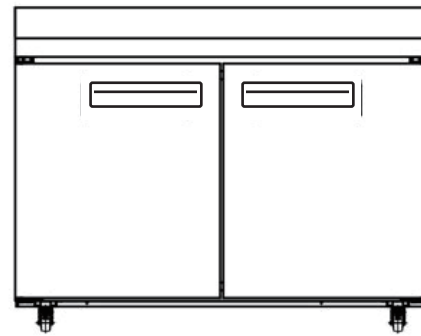
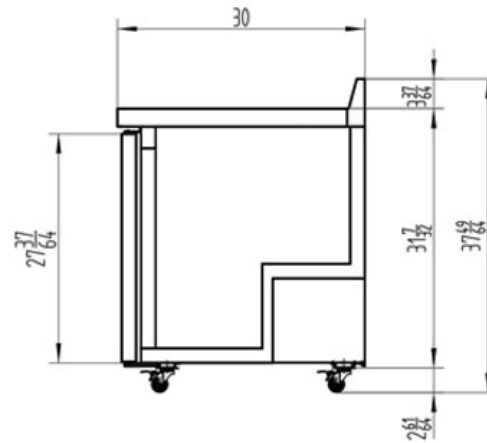
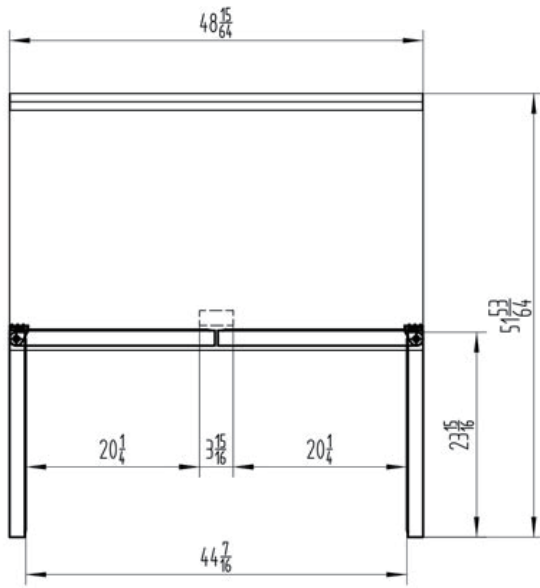

Model	Refrigerant	Doors	Shelves	Dimension (mm / inch)			HP	Voltage	Amps	Capacity (L / Cu Ft.)	Net Weight (KG / LBS)	Temperature Range
				L	D	H						
FWDR2-48VC	R290	2	2	1225	762	959	1/3	115/60	2.6	379	94	-8 ~ -1°F
				48.2	30.0	37.8				13.4	207	-22 ~ -18°C

Equipped with one NEMA 5-15P plug 

Shipping Information

Crate Dimensions (mm / inch)			Net Weight (KG / LBS)	Gross Weight (KG / LBS)
L	D	H		
1280	831	1077	97	115
50.4	32.7	42.4	213	253

Specifications subject to change without notice.